

321283 ✓ ACTIVE



PIDG

TE Internal #: 321283

Ring Terminals & Spade Terminals, Rectangular Tongue, 16 – 14 AWG Wire Size, 1.25 – 2 mm² Wire Size, 2050 – 5180 CMA Wire Size, PIDG

[View on TE.com >](#)

Terminals & Splices > Ring Terminals & Spade Terminals > PIDG Rectangular Tongue Terminals

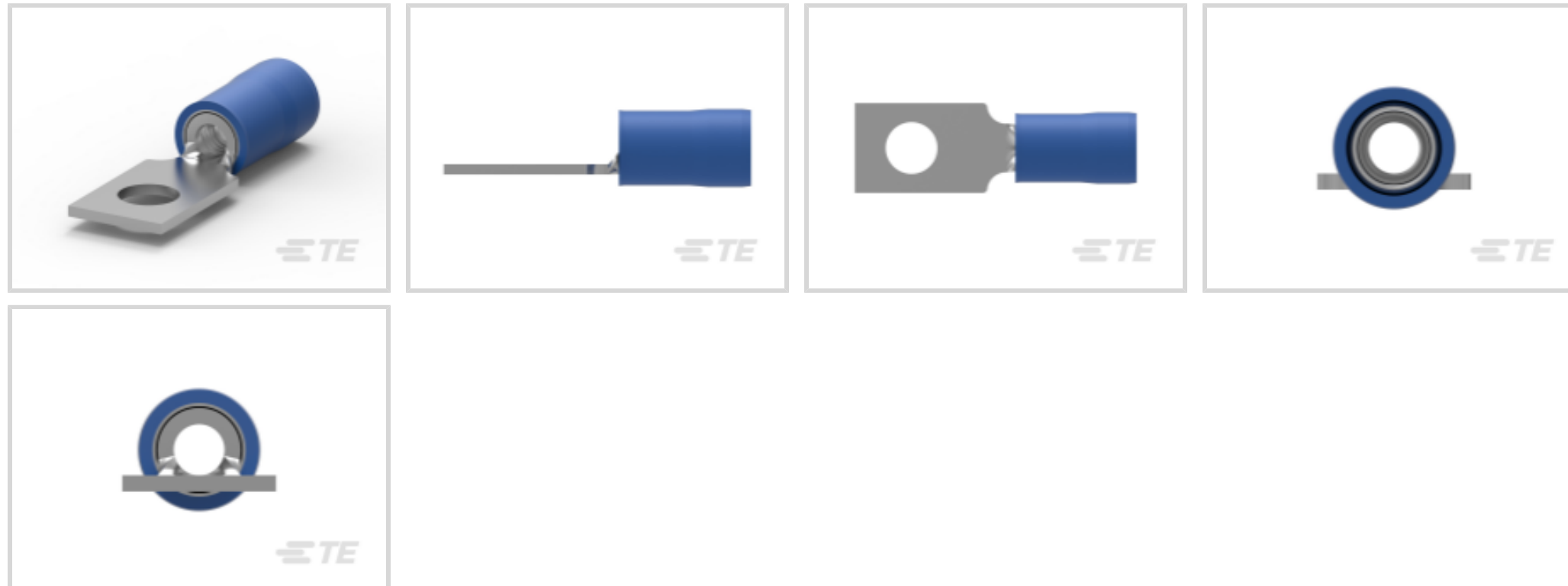

Ring & Spade Terminal Type: **Rectangular Tongue**

Wire Size: **2050 – 5180 CMA**

Stud Size: **#8, M4**

[All PIDG Rectangular Tongue Terminals \(31\)](#)

Features

Product Type Features

Shape Description	RING-055
Stud Size	#8, M4
Sealable	No
Wire Insulation Support Retention Type	Non-Insulation Support

Configuration Features

Number of Holes	1
Terminal Angle	180 °

Electrical Characteristics

Voltage (Max)	300 V
---------------	-------

Body Features

Weight per Piece	1.152 g
------------------	---------

Contact Features

Ring & Spade Terminal Type	Rectangular Tongue
----------------------------	--------------------



Barrel Type	Closed
-------------	--------

Terminal Orientation	Straight
----------------------	----------

Terminal Plating Material	Tin
---------------------------	-----

Mechanical Attachment

Wire Insulation Support	With
-------------------------	------

Dimensions

Wire Size	2050 – 5180 CMA
-----------	-----------------

Stud Diameter	4.17 mm[.164 in]
---------------	------------------

Tongue Thickness	.84 mm[.033 in]
------------------	-----------------

Overall Product Length	23.9 mm[.939 in]
------------------------	------------------

Accepts Wire Insulation Diameter (Max)	4.32 mm[.17 in]
--	-----------------

Accepts Wire Insulation Diameter Range	2.92 – 4.31 mm[.115 – .17 in]
--	-------------------------------

Usage Conditions

Insulation Option	Partially Insulated
-------------------	---------------------

Operating Temperature Range	-40 – 105 °C[-40 – 221 °F]
-----------------------------	----------------------------

Operation/Application

Compatible With Wire Base Material	Copper
------------------------------------	--------

Compatible With Wire Plating Material	Tin
---------------------------------------	-----

Heavy Duty	No
------------	----

Industry Standards

Government Qualified	No
----------------------	----

Packaging Features

Packaging Quantity	1000
--------------------	------

Packaging Method	Box
------------------	-----

Product Compliance

[For compliance documentation, visit the product page on TE.com>](#)

EU RoHS Directive 2011/65/EU	Compliant
------------------------------	-----------

EU ELV Directive 2000/53/EC	Compliant
-----------------------------	-----------

China RoHS 2 Directive MIIT Order No 32, 2016	No Restricted Materials Above Threshold
---	---

EU REACH Regulation (EC) No. 1907/2006	Current ECHA Candidate List: JUNE 2022 (224)
--	--



Candidate List Declared Against: JUNE 2022 (224)

Does not contain REACH SVHC

Halogen Content

Low Halogen - Br, Cl, F, I < 900 ppm per homogenous material. Also BFR/CFR/PVC Free

Solder Process Capability

Not applicable for solder process capability

Product Compliance Disclaimer

This information is provided based on reasonable inquiry of our suppliers and represents our current actual knowledge based on the information they provided. This information is subject to change. The part numbers that TE has identified as EU RoHS compliant have a maximum concentration of 0.1% by weight in homogenous materials for lead, hexavalent chromium, mercury, PBB, PBDE, DBP, BBP, DEHP, DIBP, and 0.01% for cadmium, or qualify for an exemption to these limits as defined in the Annexes of Directive 2011/65/EU (RoHS2). Finished electrical and electronic equipment products will be CE marked as required by Directive 2011/65/EU. Components may not be CE marked. Additionally, the part numbers that TE has identified as EU ELV compliant have a maximum concentration of 0.1% by weight in homogenous materials for lead, hexavalent chromium, and mercury, and 0.01% for cadmium, or qualify for an exemption to these limits as defined in the Annexes of Directive 2000/53/EC (ELV). Regarding the REACH Regulation, the information TE provides on SVHC in articles for this part number is based on the latest European Chemicals Agency (ECHA) 'Guidance on requirements for substances in articles' posted at this URL: <https://echa.europa.eu/guidance-documents/guidance-on-reach>

Compatible Parts

TE Part # 59824-1
TETRA-CRIMP PIDG PG FASTON 22-10 ASSY

TE Part # 58433-3
PRO CR ASSY, RBY IS9252

TE Part # 59250
T-HEAD PIDG 26-14 ASSY

TE Part # 47387
DAHT PG PIDG 20-14 ASSY

TE Part # 58423-1
DIE, RBY IS9252

TE Part # 47387-7
DAHT PG PIDG 16-12 ASSY

TE Part # 525691
DAHT PG PIDG 16-14 ASSY

TE Part # 539691-2
ERGO DIE R.B.Y

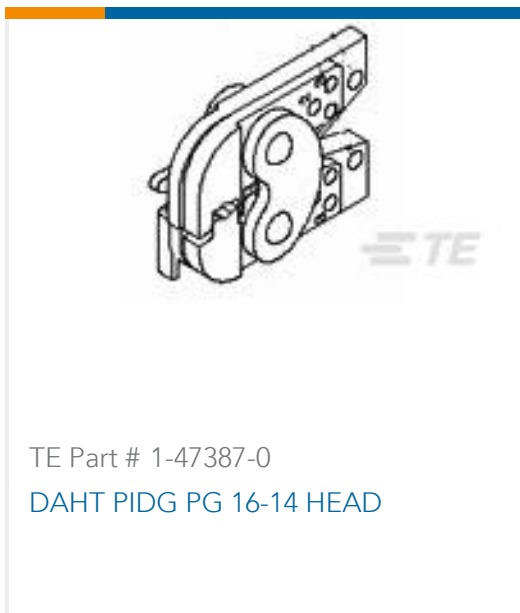

Also in the Series | PIDG

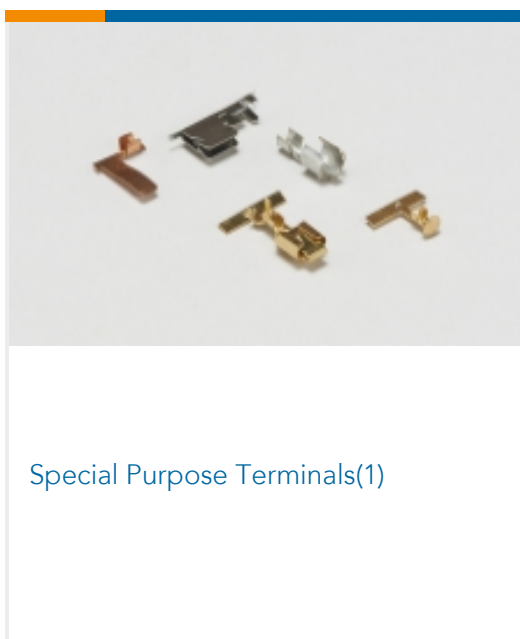
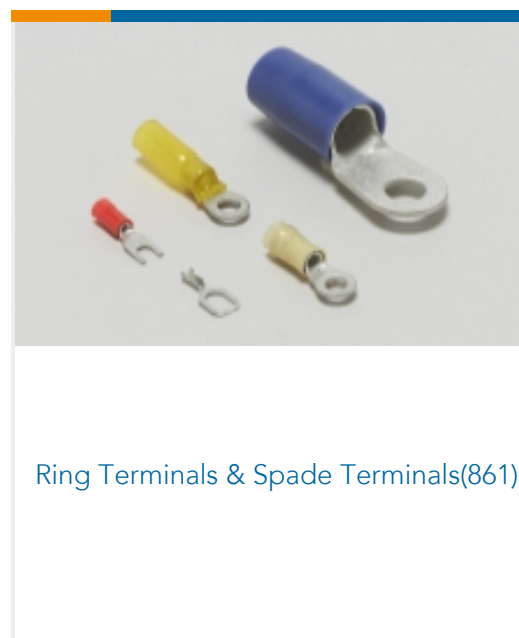
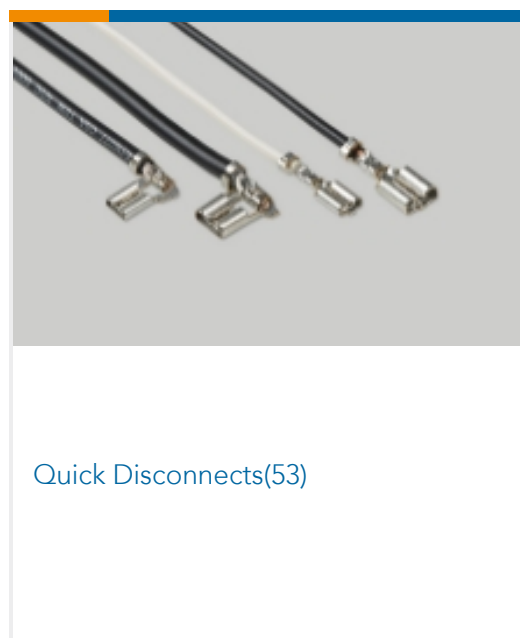
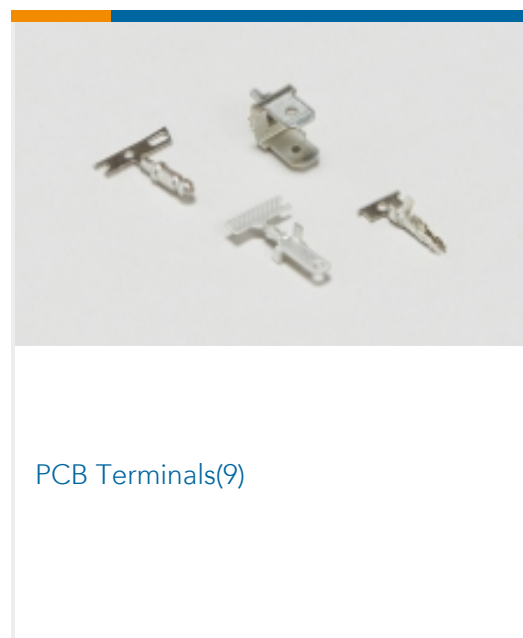
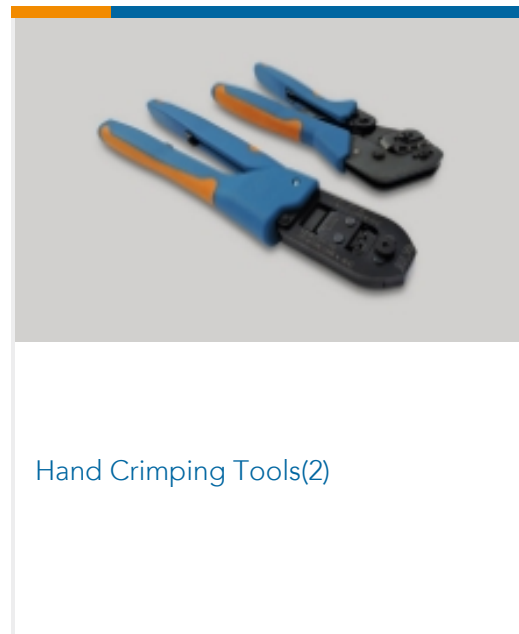
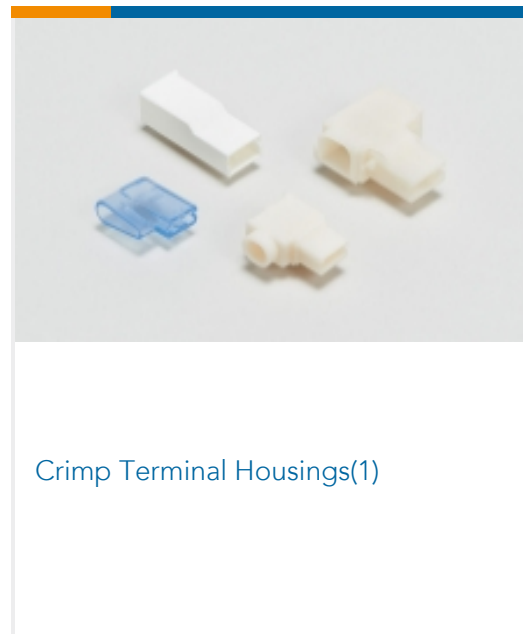
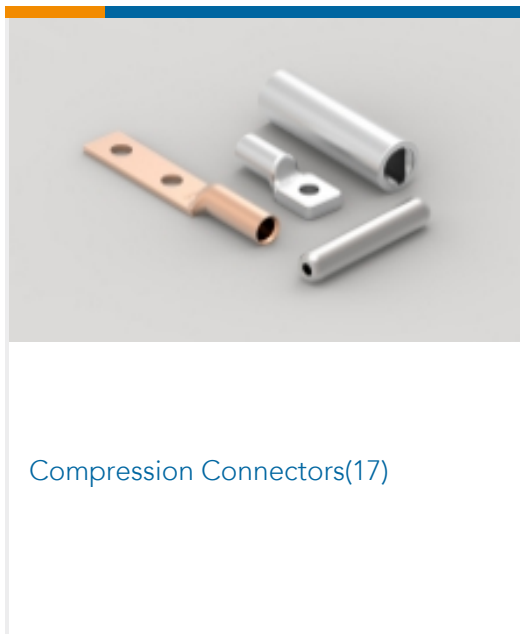

Documents



Product Drawings

[TERMINAL,PIDG RECT 16-14 8](#)

English

CAD Files

[3D PDF](#)

3D

Customer View Model

[ENG_CVM_CVM_321283_E.2d_dxf.zip](#)

English

Customer View Model

[ENG_CVM_CVM_321283_E.3d_igs.zip](#)

English

Customer View Model

[ENG_CVM_CVM_321283_E.3d_stp.zip](#)

English

By downloading the CAD file I accept and agree to the [Terms and Conditions](#) of use.

Product Specifications

[Application Specification](#)

English

Agency Approvals

[UL Report](#)

English